



Electrolux
PROFESSIONAL

**PLUS - Static Preparation
1200 mm Wall Cupboard with 2
Sliding Doors**

ITEM # _____

MODEL # _____

NAME # _____

SIS # _____

AIA # _____



134077 (GPS1200E)

Wall Cupboard with 1 shelf
and 2 sliding doors, 1200mm

Short Form Specification

Item No. _____

Made entirely from 304 AISI stainless steel, 0,8mm in thickness. Inner welded frame in stainless steel. Upturned panel edges. 10mm radiused corner between base and back panel for a perfect cleanability. 50mm top and base panel. Intermediate shelf adjustable at three different heights. Two sound-deadened sliding doors.

Main Features

- Enhanced stability and solid construction. Stability, loading and stress tests by external certified body.
- Product range suitable for international tenders requirements for intense usage installations.

Construction

- Door sliding system is fluent and reliable, tested with over 80.000 cycles by external certified body.
- Constructed entirely in 304 AISI stainless steel.
- Sliding doors are in stainless steel and double-walled with sound-deadening material inside. They are 7/10mm in thickness with roll bearings and end limit stop.
- Cupboard interior has easy access thanks to completely openable doors.
- Intermediate shelf has 40mm high profile, is 8/10 in thickness with upturned edges and bar reinforcement. It can be positioned at three different heights.
- Base panel has 40mm high profile, is 8/10 in thickness with upturned edges and bar reinforcement.

APPROVAL: _____



Experience the Excellence
www.electroluxprofessional.com

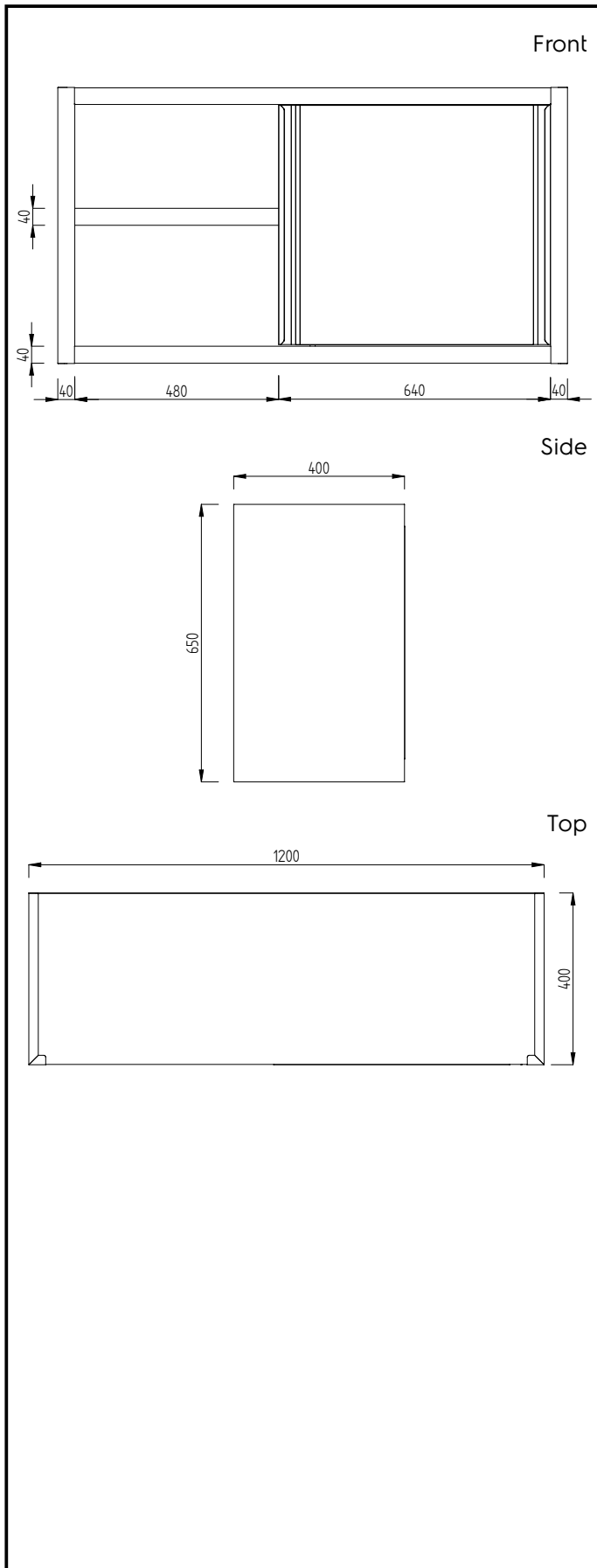

Key Information:

Cabinet width:	
134077 (GPS1200E)	1120 mm
Cabinet depth:	360 mm
Cabinet height:	580 mm
N° of doors:	2
External dimensions, Width:	1200 mm
External dimensions, Depth:	400 mm
External dimensions, Height:	650 mm
Net weight:	33 kg